

TR-WE45-IN PTZ Dome Wall Mount



Specifications

Bracket	TR-WE45-IN
Application	Indoor or outdoor, wall installation for PTZ dome camera
Dimensions(L × W × H)	230.3mmx141mmx201.5mm (9.1"x5.6"x7.9")
Weight	0.79kg(1.74lb)
Material	Aluminum alloy

Dimensions

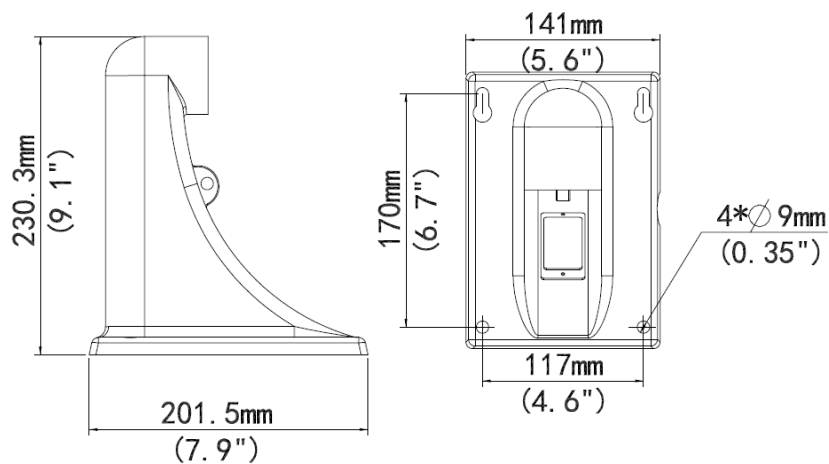

Zhejiang Uniview Technologies Co.,Ltd.

South Tower, Building 10, Wanlun Science Park, 88 Jiangling Road, Hangzhou, P.R.China 310051

Email: overseasbusiness@uniview.com; globalsupport@uniview.com

<http://www.uniview.com>

©2013 Zhejiang Uniview Technologies Co.,Ltd. All rights reserved.

*Product specifications and availability are subject to change without notice.